

Lok-Fast – Hi-Shear Cross reference  
Lok-Fast – Hi-Shear H.S. Tooling Cross Reference

I Pistol Grip Driver

Hi-Shear  
Lok-Fast

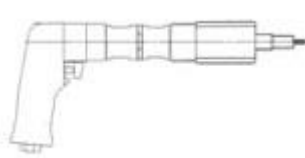

Super HLA 1051  
SDA4 SERIES  
Page 8

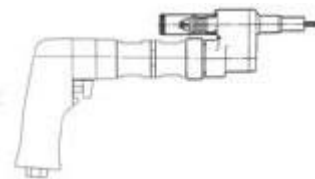

Super HLA 1066  
N/A

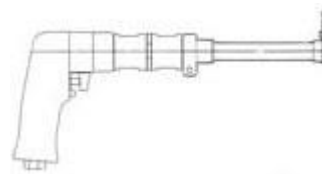

Super HLA 1071  
IL3-3 FLUSH (\*)  
Page 7

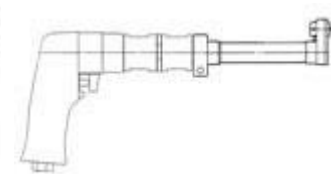

Super HLA 1072  
IQLA33L- EXTENDED (\*)  
Page 7

Hi-Shear  
Lok-Fast

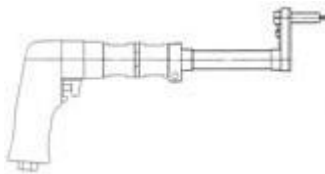

Super HLA 1076  
IQLA34L-EXTENDED (\*)  
Page 7

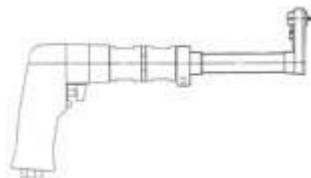

Super HLA 1079  
IQLA34L-FLUSH (\*)  
Page 7

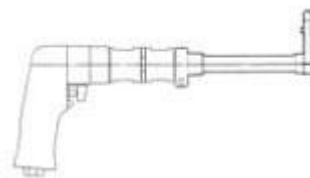

Super HLA 1084  
IL34-FLUSH (\*)  
Page 7

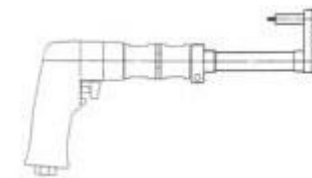

Super HLA 1086  
IQLA34L-EXTENDED-  
BACKDRIVE (\*)  
Page 7

(\*) Hi-Shear doesn't advertise tools other than 250 RPM we offer the 350 RPM and 500RPM for example:  
HLA 1076 could be IQLA34L OR IQLA54L.

(\*\*) Without: Quick Change Removal Socket.

Lok-Fast – Hi-Shear Cross reference  
Lok-Fast – Hi-Shear H.S. Tooling Cross Reference

**I Pistol Grip Driver  
(Cont.)**

Hi-Shear  
Lok-Fast

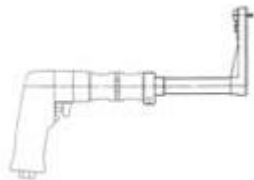

Super HLA 1097  
IQLA37L FLUSH (\*)  
Page 7

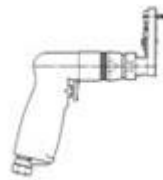

Super HLA 1201  
MQCLA43S-FLUSH (\*\*)  
Page 19



Super HLA 1202  
MQCLA45S-FLUSH  
Page 19

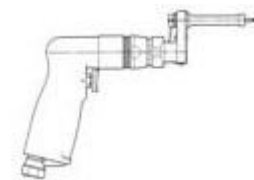

Super HLA 1203  
MQCLA45S-EXTENDED  
Page 19

Hi-Shear  
Lok-Fast

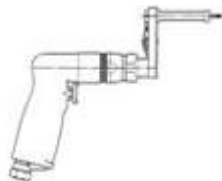

Super HLA 1204  
MQCLA45S-EXTENDED  
Page 19

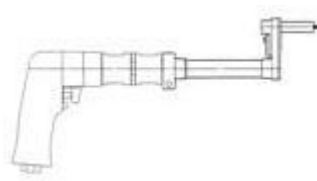

Super HLA 2068  
IQLA34L-EXTENDED (\*)  
Page 7



Super HLA 3023  
IQLA39L-EXTENDED  
BACKDRIVE (\*)  
Page 7

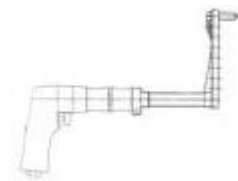



Super HLA 3025  
IQLA39L-EXTENDED (\*)  
Page 7

(\*)Hi-Shear doesn't advertise tools other than 250 RPM we offer the 350 RPM and 500RPM for example:  
HLA 1076 could be IQLA34L OR IQLA54L.  
(\*\*) Without: Quick Change Removal Socket.

Lok-Fast – Hi-Shear Cross reference  
Lok-Fast – Hi-Shear H.S. Tooling Cross Reference

I Ratchet Driver

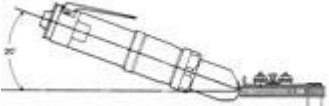
				
Hi-Shear Lok-Fast	Super HLA 2002 QSRA10-EXTENDED SERIES Page 9	Super HLA 2006 QSRA10-FLUSH SERIES Page 9	Super HLA 2008 QRA10-FLUSH SERIES Page 10	Super HLA 2016 QRA10-EXTENDED SERIES Page 10

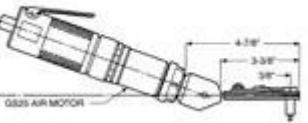
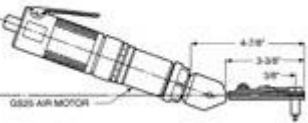
				
Hi-Shear Lok-Fast	HLA 2026 QRA10-FLUSH Page 10	Super HLA 2033 R1000-“SOCKET” FLUSH SERIES Page 10	Super HLA 2073 QRA6-EXTENDED SERIES Page 10	Super HLA 2075 QRA6-EXTENDED SERIES Page 10

Lok-Fast – Hi-Shear Cross reference  
Lok-Fast – Hi-Shear H.S. Tooling Cross Reference

**I Ratchet Driver**

(Cont.)

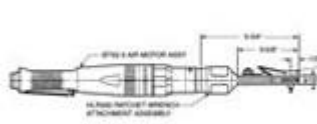

Hi-Shear  
Lok-Fast

HLA 3000  
R-HIGH TORQUE  
SERIES  
See New  
Products Catalog

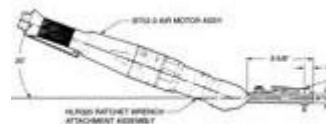

HLA 3020  
OR-HIGH TORQUE  
SERIES  
See New  
Products Catalog

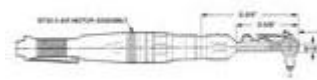

Super HLA 3502  
R-HIGH TORQUE  
SERIES  
See New  
Products Catalog

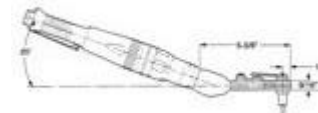

HLA 3522  
QRA10-EXTENDED  
SERIES  
Page 10



Hi-Shear  
Lok-Fast

HLA 4001  
R-HIGH TORQUE  
SERIES  
See New  
Products Catalog



HLA 4007  
R-HIGH TORQUE  
SERIES  
See New  
Products Catalog

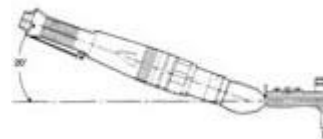

HLA 4008  
OR-HIGH TORQUE  
SERIES  
See New  
Products Catalog



HLA 4020  
OR-HIGH TORQUE  
SERIES  
See New  
Products Catalog

Lok-Fast – Hi-Shear Cross reference  
Lok-Fast – Hi-Shear H.S. Tooling Cross Reference

I Socket Assembly

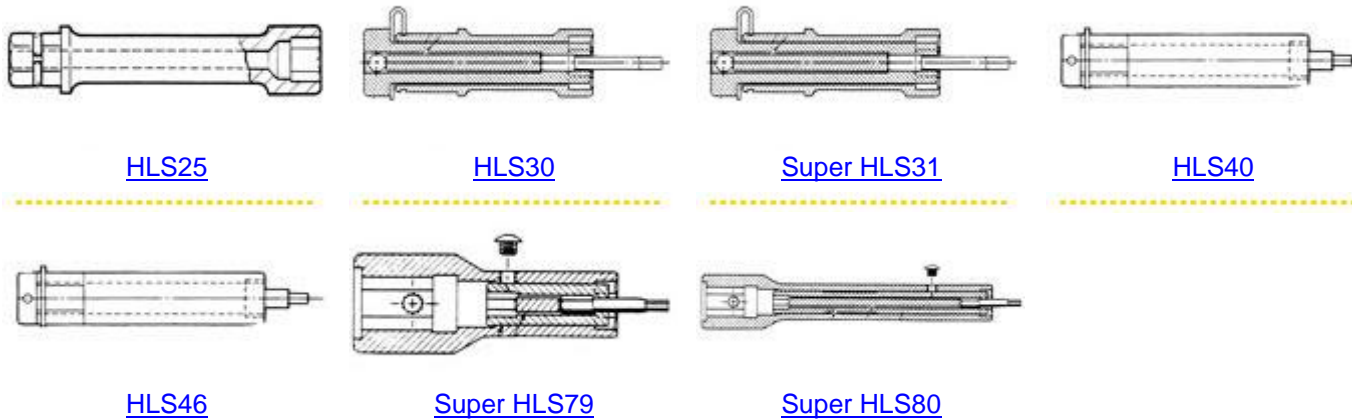

I Hand Tool

